

6-GFM(G)-150Ah

Gel Battery Specification

Features

- Maintenance free
- Safety and no leakage
- Excellent recharge and discharge performance
- Low self-discharge rate
- Adapt to high or low temperature
- Good deep discharge performance
- Longer cycle life



Specification

Rated Voltage	12V
Numbers of cells	6 Cells
Capacity	150Ah@10hr-rate to 1.80V per cell @25°C
Weight	47kg
Internal Resistance	Approx. 4mΩ
Terminal	F1 / F2
Max. Discharge Current	2250A(5s)
Short Circuit Current	7500A
Max. Charging Current	37.5A
Reference Capacity	C10 150.0AH C3 108.7AH C1 82.4AH
Design Life	10~15 years
Float Charging Voltage	13.6 V~13.8 V @ 25°C Temperature Compensation: -20mV/°C/Cell
Cycle Use Voltage	14.4 V~14.9 V @ 25°C Temperature Compensation: -30mV/°C/Cell
Operating Temperature Range	Discharge: -20°C~60°C Charge: 0°C~50°C Storage: -20°C~60°C
Normal Operating Temperature Range	25°C±5°C
Self Discharge	Less than 3% at 25°C per month
Container Material	A.B.S. UL94-HB, UL94-V0 Optional.

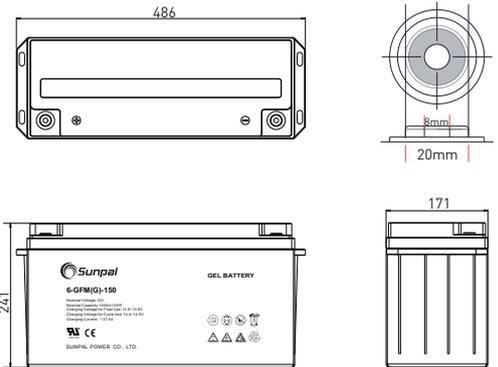

Length	486±2mm (19.1 inches)
Width	171±1mm (6.7 inches)
Height	241±1mm (9.5 inches)
Total Height	241±1mm (9.5 inches)

Constant Current Discharge Characteristics: A(25°C)

F.V/Time	5min	10min	15min	20min	30min	45min	1h	3h	5h	10h	20h
1.80V/cell	159.51	122.20	91.95	77.07	47.93	36.22	25.37	21.83	17.44	15.00	8.23
1.75V/cell	179.27	134.39	99.39	82.44	50.73	38.17	26.34	22.68	17.93	15.32	8.40
1.70V/cell	193.17	143.90	105.61	87.32	53.78	39.76	27.20	23.41	18.54	15.73	8.50
1.65V/cell	200.98	149.51	109.27	90.61	55.24	41.10	27.68	23.78	18.78	15.85	8.59
1.60V/cell	217.80	160.00	117.44	96.10	57.44	42.68	28.54	24.39	19.15	16.22	8.71

Constant Power Discharge Characteristics: WPC(25°C)

F.V/Time	5min	10min	15min	20min	30min	45min	1h	3h	5h	10h	20h
1.80V/cell	301.34	233.17	177.07	149.27	93.17	70.61	49.88	43.17	34.63	29.88	16.46
1.75V/cell	334.88	254.15	190.00	158.90	98.54	74.39	51.71	44.51	35.61	30.49	16.71
1.70V/cell	356.83	269.76	200.24	167.20	103.90	77.32	53.17	45.98	36.59	31.10	16.95
1.65V/cell	367.32	277.44	205.98	172.44	106.10	79.39	54.02	46.59	37.07	31.46	17.07
1.60V/cell	393.54	294.15	219.63	182.20	109.76	82.20	55.61	47.56	37.67	32.01	17.32

6-GFM(G)-150Ah

Gel Battery Specification

Charge Characteristics for Float Use @ 25°C/77°F

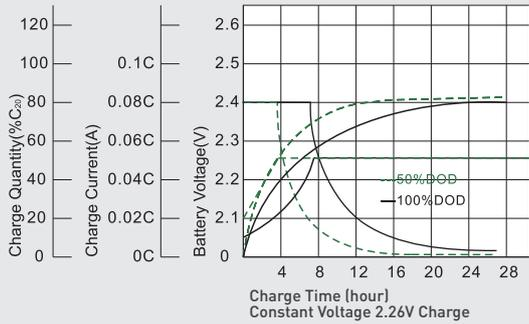

Discharge Characteristics at Various Rates @ 25°C/77°F

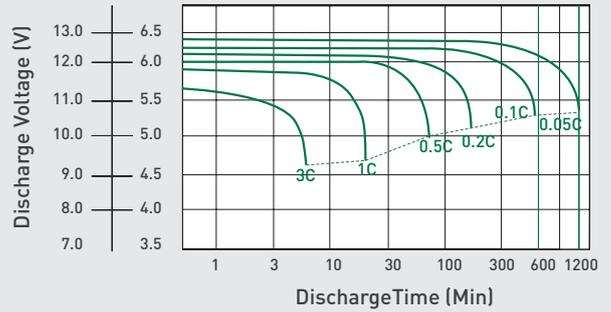

Cycle Life in Relation to Depth of Discharge

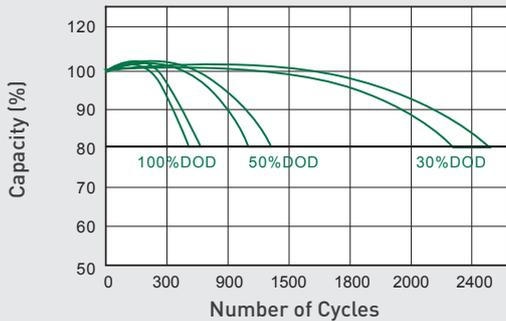

Float Service Life

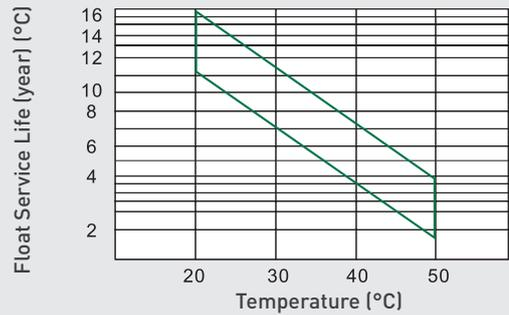

Temperature and Valid Capacity

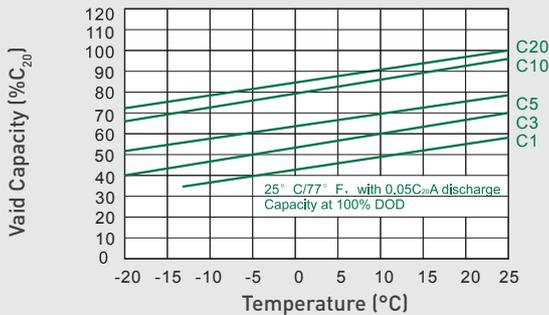

Self Discharge Characteristics

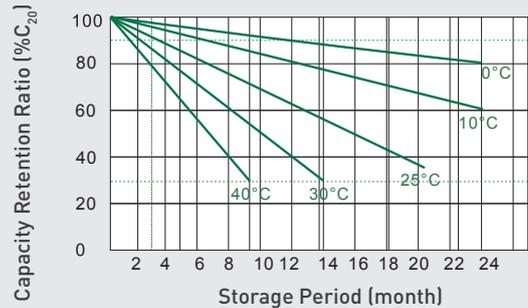

Capacity and Open Circuit Voltage

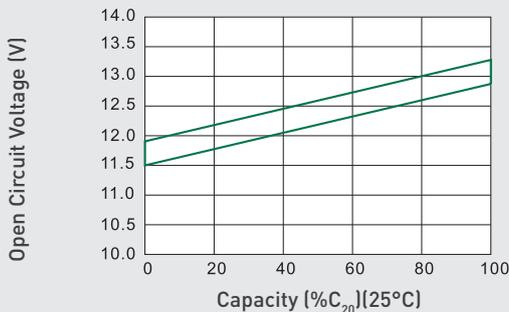

Relationship between Charging Voltage and Temperature

